

Packing List

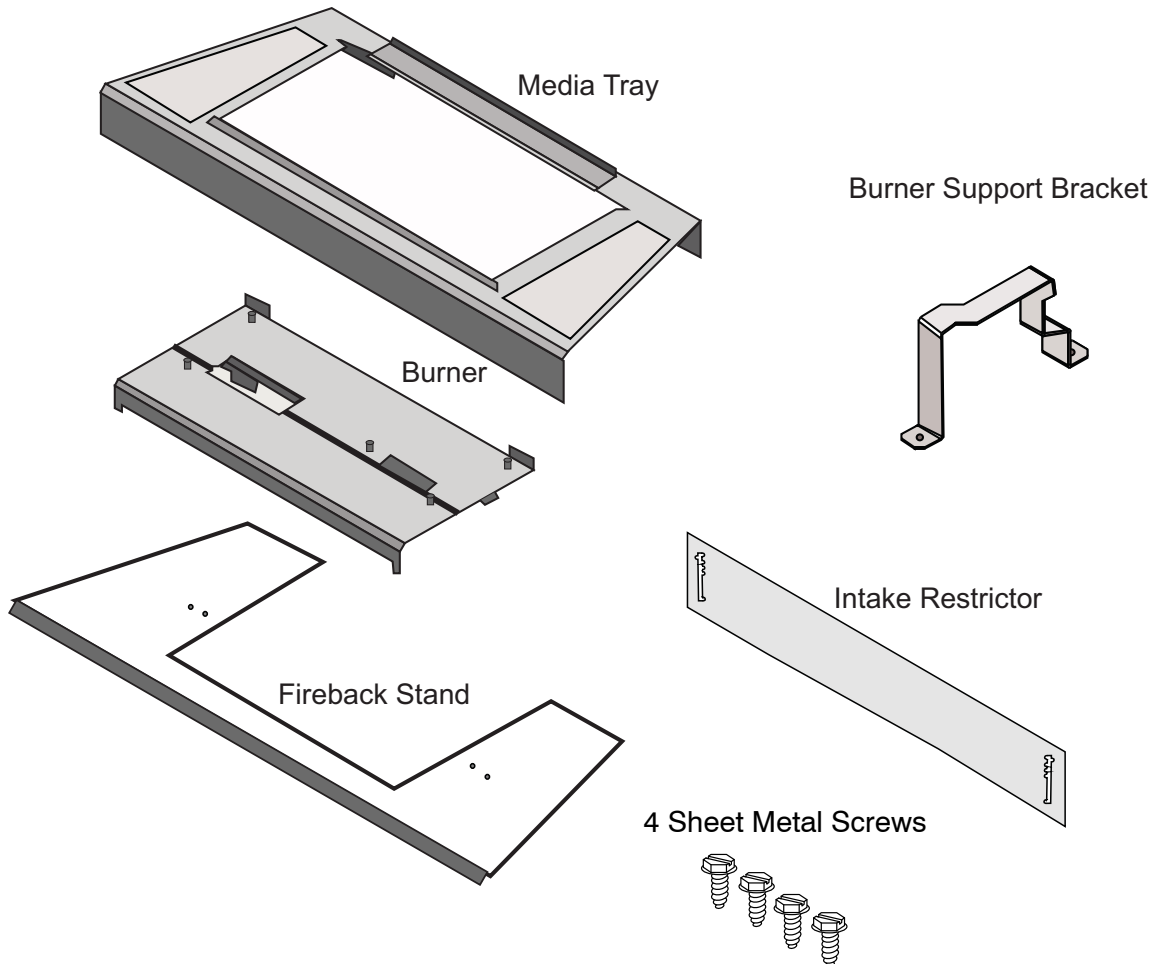

Installation Tips



If using propane (LP), convert the appliance before installing the burner.



Make sure to have the firebacks for the appliance on hand. They will be installed during burner installation.

Installation Warnings



Make sure the gas control valve is OFF and the heater is cool before servicing.



Failure to position the parts in accordance with these diagrams or failure to use only parts specifically approved with this appliance may result in property damage or personal injury.



The burner must be correctly positioned before installing the media (driftwood, stones, etc.). Make sure the burner is fully seated and the pilot is properly aligned.

Burner Installation

1. Remove both accent light assemblies from the brackets at the rear of the firebox (discard the screws). Remove and discard the front light cover from both assemblies. See Figure 2 below. Place the accent light assemblies in the center of the firebox floor, as shown below.

NOTE: Do not touch the bulbs.

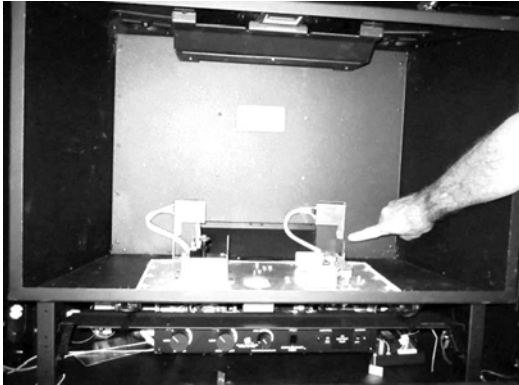

Figure 1: Accent light bracket screws location



Figure 2: Remove front light cover

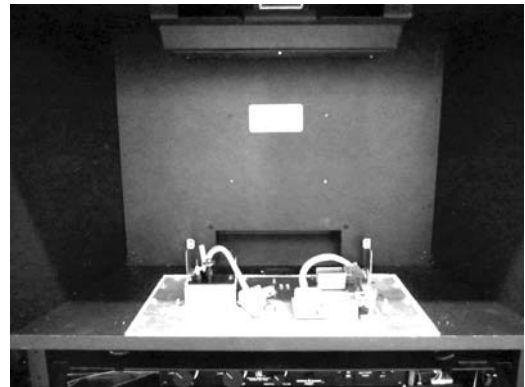

Figure 3: Accent lights placed on firebox floor

2. Install the intake restrictor as shown below, using the existing screws on the rear wall of the firebox.

Set the intake restrictor to the correct setting for the vent configuration. See the installation manual for details.

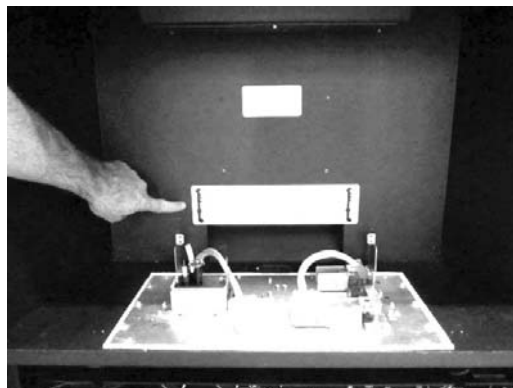

Figure 4: Intake restrictor installed, showing location of screws

564 HO DiamondFyre Burner Installation Instructions (sku: 96900115)

3. Install the burner support bracket at the left side of the firebox, as shown below.

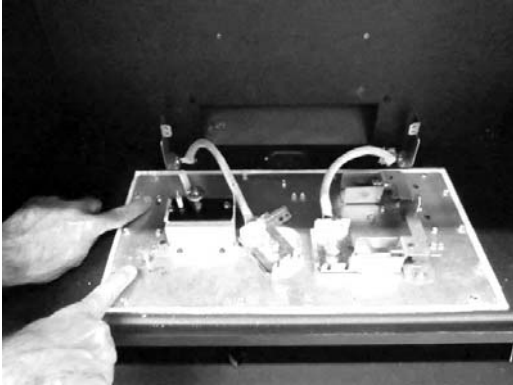

Figure 5: Burner support bracket screws location

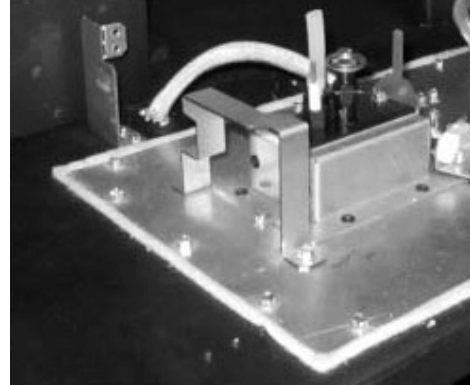
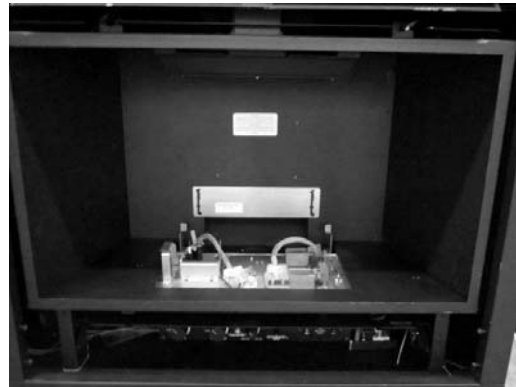

Figure 6: Burner support bracket installed

4. Install the fireback stand into the firebox, as shown below.



564 HO DiamondFyre Burner Installation Instructions (sku: 96900115)

5. Install the rear, left, and right firebacks as shown below.

- a Remove the clip located on the firebox ceiling near the front (both sides). The side fireback clip has a keyhole slot. It can be removed by loosening the screw and sliding the clip out.

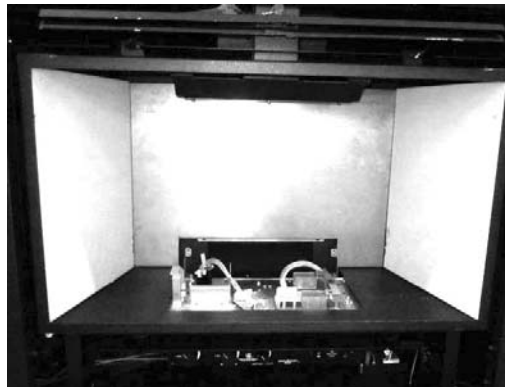
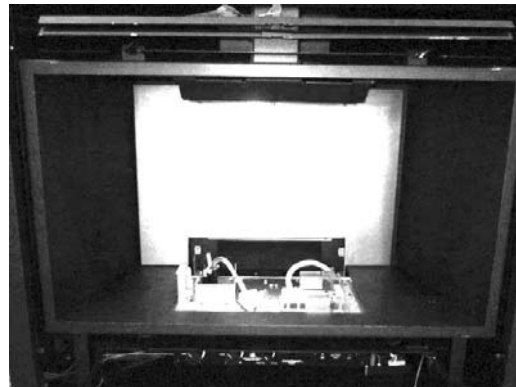
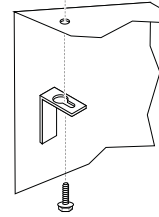

STAINLESS STEEL WARNINGS

HANDLING THE FIREBACKS: The stainless steel firebacks are shipped in vinyl to prevent marring the surface of the stainless steel. Remove the vinyl prior to installation. **Wear clean gloves when installing the firebacks** to prevent fingerprints on the surface (or use a rag or paper towel to handle the firebacks).

COLORATION AND CLEANING: These stainless steel firebacks will obtain a slight "patina" (brown tint) after use. Do not clean the firebacks. This patina becomes consistent. Any cleaning may lead to unequal coloring. If soot forms on the fireback, we recommend brushing it off with a soft cloth or brush.

Replace the fireback clips shown in step "A" after installing the firebacks.

564 HO DiamondFyre Burner Installation Instructions (sku: 96900115)

6. Attach the accent lights to the fireback stand using the 4 included sheet metal screws.

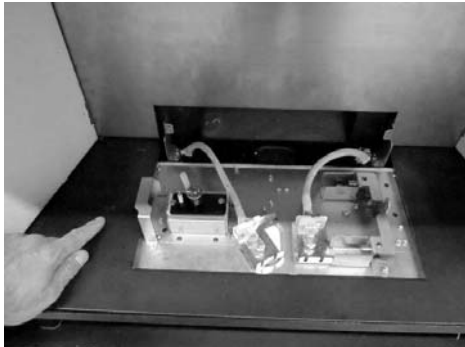

Figure 7: Accent lights screws location

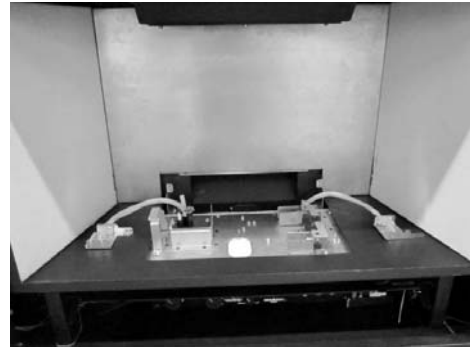

Figure 8: Accent lights attached

7. Install the burner inside the firebox.



8. Install the media tray.



564 HO DiamondFyre Burner Installation Instructions (sku: 96900115)

9. Install the front fireback skirt at the front of the fireplace. Note how the skirt overlaps the media tray.

